

The combination of the Mobi App and Mobi Board replaces the Optimizer, Downloader and Downloader Windows program.

The Mobi App (for Android™) acts as a Graphical User Interface to the the Mobi Board. The Mobi Board provides a Bluetooth® wireless interface to Motorscope® Products.

**HOW TO DOWNLOAD THE APP:**

1. Use your Smart Device and go to the App Store / Google Play.
2. Search for "Nist MOBI" 
3. Choose Install --> Accept --> Open  
(The Mobi App will open. Choose the Motorscope you wish to view.)
4. All variables will be visible.



Alternatively, scan the appropriate QR code:



**HOW TO USE THE APP:**

2. Tap on  at the top left corner and choose "Tutorial".

**CALIBRATION WITH MOBI BOARD:**

**ALWAYS START WITH STEPS 1+2, EVEN WHEN ALREADY UNCALIBRATED**

1. With the Motorscope switched OFF, make sure the jumper is connected on both pins.
2. Hold in Calibration Button while switching the Motorscope ON. All three LED's must come ON. (Meaning UNCALIBRATED).
3. Connect with the Mobi App to the Motorscope.
4. The Mobi App will show "Uncalibrated".
5. Press "Calibrate" to follow the Calibration Wizard.

**PROTECTION**

OVER-&-UNDER-LOAD

OVER-&-UNDERVOLTAGE

OVERHEATING (Uncontrolled Starts)

NOT AGAINST LIGHTNING

**GENERAL INFORMATION**

The power used by a working system varies with the application but must stay within safe limits. Power consumption outside of this range indicates a faulty motor or system. The load or power consumption is measured at the input to the motor.

When the calibration button is pressed, with the jumper in place, the MOTORSCOPE defines the safe range for the system. The motor must, at that time, run under normal working conditions. The power supply has to be correct and stable, this is checked continuously. The MOTORSCOPE keeps the motor running as long as the safe limits are not exceeded.

The MOTORSCOPE has a RS232 output for serial communication with our MOBI / OPTIMIZER or a PC. The MOBI / OPTIMIZER is used to improve settings, as an installation aid and for more detailed fault indication.

The MOBI / OPTIMIZER can carry the data of the last 43 motor stops to be transferred to a PC or viewed on our App.

**DO NOT MOUNT THE UNIT IN FULL SUN!**

**TECHNICAL SPECS**

MOTOR VOLTAGE	: 230V AC
CURRENT RANGE	: 1 - 20 Amp Inductive
POWER RANGE	: 0.25 - 2.2kW
FREQUENCY RANGE	: 40 - 70 Hz
CONSUMPTION	: 3VA
RELAY OUTPUT	: 230V - 16A
COS PHI RANGE	: 0 - 1 Inductive
TEMP RANGE	: -15 to +70° C
MECHANICAL	: Weight ±350grams
DIMENSIONS	: 85 x 130 x 50mm

**OPTIONAL:**  
Every Unit can be fitted with our new **MOBI BOARD** for your convenience!

Scan This QR Code To Be Directed To Our YouTube Channel To View A Full Demo Video Or Short Tutorial Videos



## Installation Instructions

1. Megger the motor and measure the winding resistances.
2. Connect the incoming power (Live, Neutral and Earth) to the Uno-panel as indicated on the diagram below. **Note: If unit is powered from a generator, Earth & Neutral MUST be linked.**
3. Connect the outgoing power to the motor as per diagram (Do not forget to earth the motor as indicated).
4. When all connections are properly fastened, proceed with the First Time Calibration.

### CONNECTION DIAGRAM FOR 0.25-0.75kW MOTORS

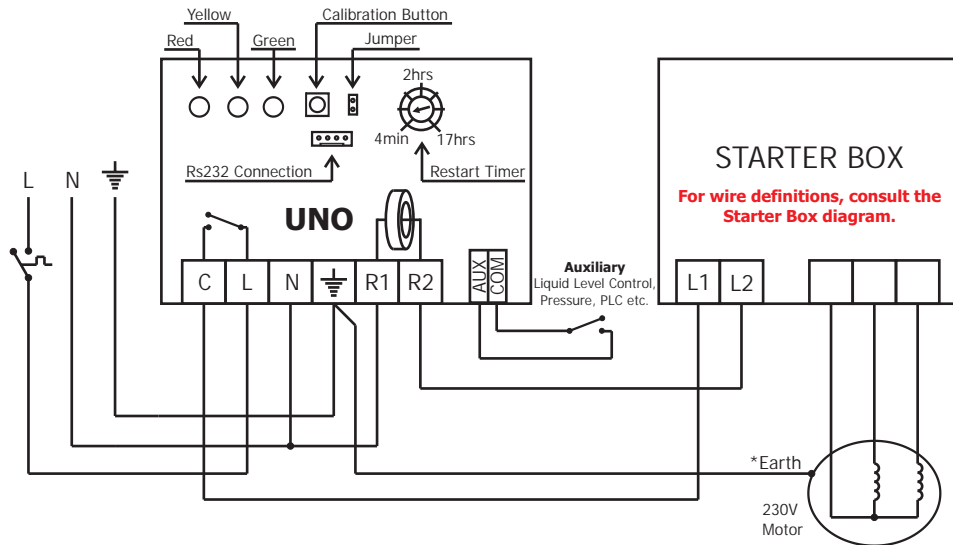

### CONNECTION DIAGRAM FOR 1.1 - 2.2kW MOTORS

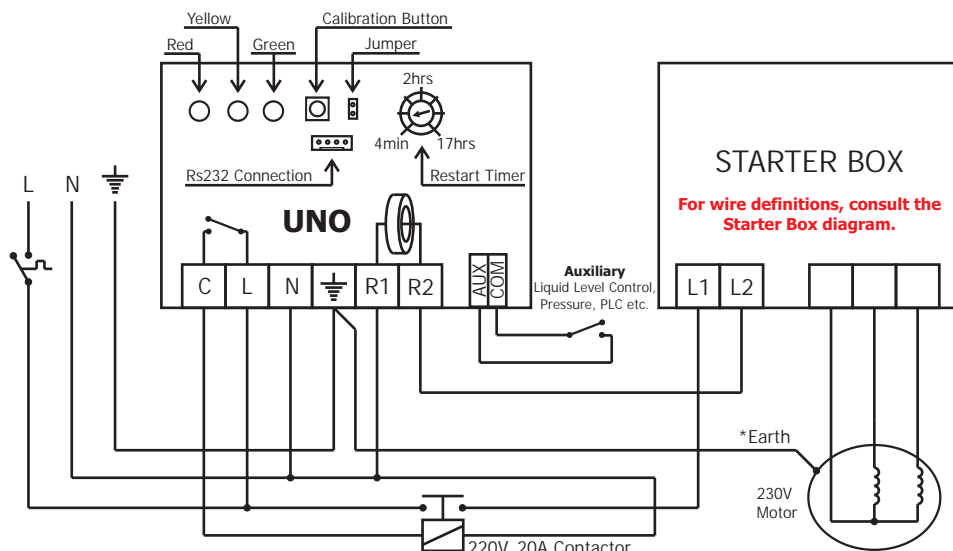

### FIRST TIME CALIBRATION: \*\*\* For MOBI Calibration, please refer to page 1) \*\*\*

(Ensure that all wires and the motor's earth are properly connected before **First Time Calibration**)

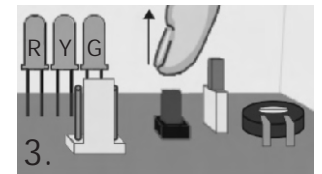
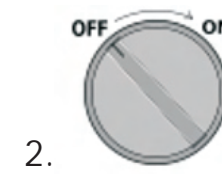
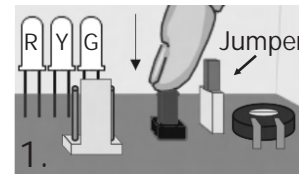

Connect the **jumper** to the two pins as indicated above. Press the **calibration button** while switching the power on at the **ON/OFF** switch on the bottom of the unit.

When all the indication lights glow, release the **calibration button** for one second.

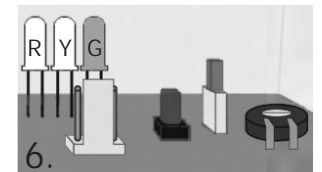
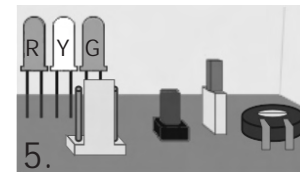
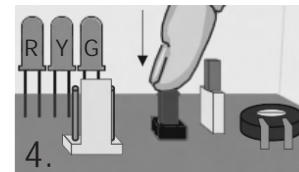

Press the **calibration button** again until the motor starts ( $\pm$  3 sec). The calibration will start automatically.

First the **RED** and **GREEN** light will glow for 4 seconds, indicating that calibration is in progress.

The calibration is completed when only the **GREEN** light glows.

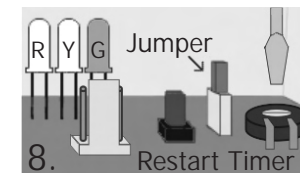
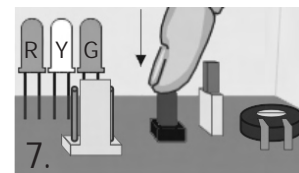

After the pump has run for approximately 5 min; press the **calibration button** again until the **RED** and **GREEN** lights glow, to optimize the automatic calibration.

Calibration is finished when only the **GREEN** light glows. Place the **jumper** on one pin to keep the set limits and to prevent tampering. Adjust the **Restart Timer** (with a screwdriver) to set the dry-run recovery time.

#### FINAL STEP:

Measure the current in ALL phases to see if it is within the motor specifications. If not, **switch the power off** & contact our technical department.

9.









#### Run, Start and Common wire definitions:

1. Four wires go down to the motor. Number them 1, 2, 3 and 4.
2. Measure resistance from:  
1 to 2 = ? | 1 to 3 = ?  
1 to 4 = ? | 2 to 3 = ?  
2 to 4 = ? | 3 to 4 = ?
3. The Earth wire (1) is not connected to any of the motor wires ("O.L." on multi-meter).
4. Highest of the other 3 measurements is between the Run and Start windings.
5. The other wire (1) is Common.
5. Run is the wire (1) with the lowest resistance from Common.
6. Start is the wire (1) with the highest resistance from Common.

**POSSIBLE ERRORS AT FIRST TIME CALIBRATION**

○ LIGHT OFF    ✨ LIGHT FLASHING

NOTE: Start fault finding by checking that all wires and compressed copper connections are properly connected, and that the motor is calibrated at it's normal running condition.

<u>LED Indications</u>	<u>Reason</u>	<u>Possible cause</u>	<u>Solution</u>
	Red & Yellow light flashing	Voltage fault (When the supply voltage recovers and stays within the safe limits for 15 min, normal operation resumes.)	Supply voltage incorrect  Connect Earth ( ) to COM. Phone your power supply company.
	Yellow light flashing	Underload / Restart Timer	Borehole dry Broken belt/shaft  Set restart-timer for borehole to refill. Contact you motor's supplier.
	Red constant & Yellow flashing	Current Fault	Over Current  Current exceeds the safe limit.
	Yellow & Green light flashing	Start Delay	Too rapid restart  Leave on, unit restarts automatically.
	Red & Yellow constant	Phase rotation error	2 Phase wires interchanged Check motor rotation  Interchange 2 phase wires at input power connector. Interchange 2 motor leads at output from contactor.
	Red constant	Overload	Low voltage at motor Overload  Use a larger diameter cable to motor Check system or contact supplier.
	Yellow constant	Underload	Borehole dry Broken belt/shaft  Set restart-timer for borehole to refill. Contact you motor's supplier.
		CT in incorrect phase	Wiring error  Check that CT is connected in L3.
	Red constant, Yellow & Green flashing	Motor can not start	Wires connected incorrectly  Follow "Run, Start and Common wire definition"  Check Run & Start Capacitors connections and sizes.