

RF TRANSCEIVER

Tel. +27 74 587 2152/61

Fax: +27 86 653 0428

nist@nistcontrol.com

FEATURES

- ? 3 Dry Contact Inputs
- ? 2 Relay Outputs (Dry Contracts)
- ? Mains or Solar Panel & Battery powered supply
- ? IP65 Enclosure
- ? RP-SMA Antenna Connector for short or long range antenna

OPTIONAL FEATURES

- Power Supply Input Voltage
- ? 12VDC (we can also supply a Solar Panel, Battery and Charger kit)
 - ? 230VAC
- Antenna
- ? Short Range (600m Line-of-Sight): Omni-directional
 - ? Long Range (3000m Line-of-Sight): Directional
- Serial Data Ports
- ? With or Without 2 Serial Ports: used to convert Motorscope Rs232 to wireless data

GENERAL INFORMATION

The RF Transceiver is a versatile Receiver / Transmitter / Repeater Remote Monitor / Control 2.4GHz Radio with true mesh networking capability (no master/co-ordinator).

TECHNICAL SPECS

POWER SUPPLY	: 230VAC, 7 Watts
SOLAR PANELS	: Voltage in 11V-15VDC 7 Watt
INPUT	: 3 - Working with dry contact (12VDC - 10mA)
OUTPUT	: 2 - Relays MAX 10A 400VAC
DIMENSIONS	: 158 x 238 x 100 (mm)
WEIGHT	: 1kg (enclosed - not packaged)

ANTENNA SPECS

SHORT RANGE	: Omni-Directional, 5dBi Magnetic base, Whip Antenna Base Ø: 30mm Length: 142mm Cable Length: 3m
LONG RANGE	: Directional, 24dBi Grid Antenna Dimintions: 600 x 900 mm Beamwidth: 10° (Horizontal) 14° (Vertical) Weight: 3.5kg (excl. packaging) Cable Length: 3m

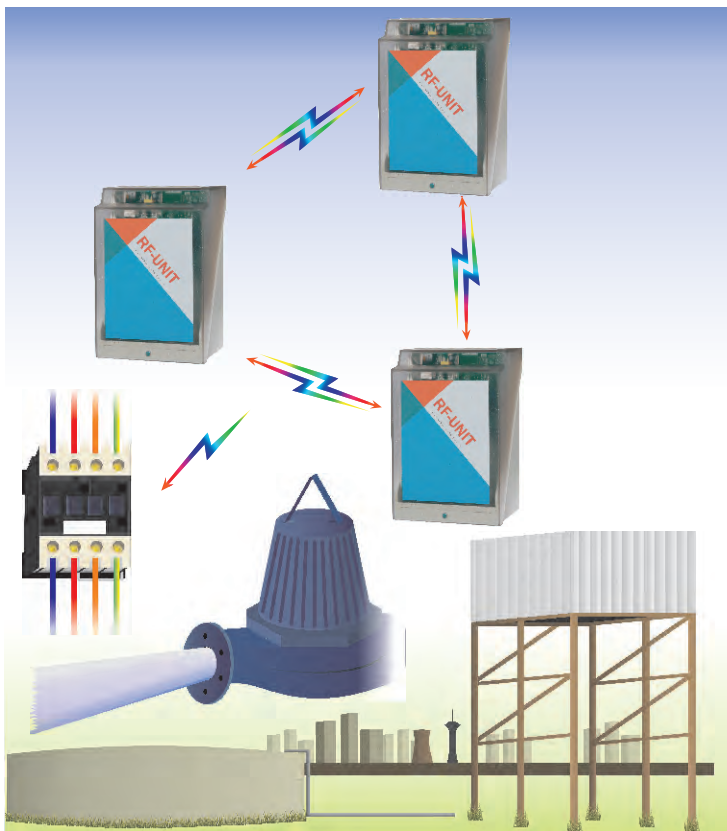

TO PROGRAM THE INPUT ON THE TRANSMITTER & THE OUTPUT ON THE RECEIVER

Disconnect the antennas from the RF-Units and lay them next to each other.

STEP 1

On both units (Transmitter & Receiver: Switch power ON.

STEP 2

Wait 1 minute.

STEP 3

On Transmitter: Switch on ONLY Input 1 (If you want to use input 1).

STEP 4

On Receiver: Switch on ONLY Output 1 (If you want to use output 1).

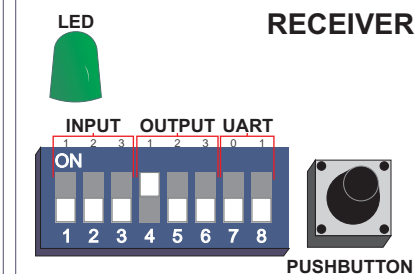
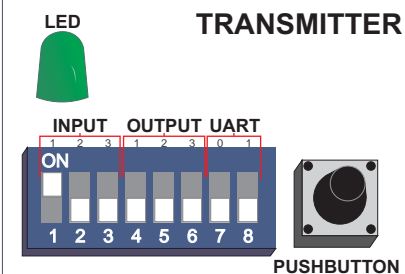

STEP 5

On both units (Transmitter & Receiver): Press the pushbuttons simultaneously for only 3 seconds. Check that the LED flashes a few times.

*The flashes indicates the strength of the received signal. The amount of flashes in 10 sec gives the signal strength. (9 Flashes = 90% signal)

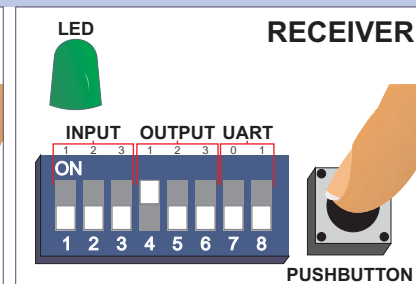
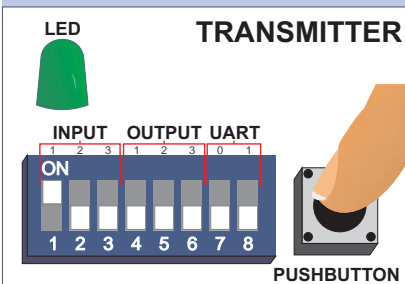

TO PROGRAM THE SERIAL PORTS ON THE TRANSMITTER & RECEIVER

Follow the same procedure as with the programming of the inputs & outputs, but here you should select the desired UART switch on the Transmitter and Receiver.

TO ERASE ALL SETTINGS (ONLY 1 RF-UNIT AT A TIME)

STEP 1

Set UART 0 (DIP switch 7) to ON.

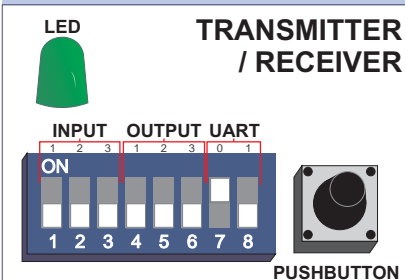

STEP 2

Press the pushbutton for 20 seconds. LED will flash 10x to indicate erase successful.

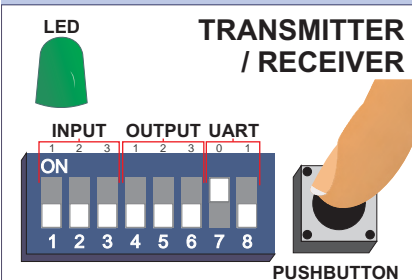

Repeat this procedure with the other RF-Unit.

TO ERASE SINGLE INPUT, OUTPUT OR UART (ONLY 1 RF-UNIT AT A TIME)

STEP 1

Set the relevant DIP switch for that Input, Output or UART.

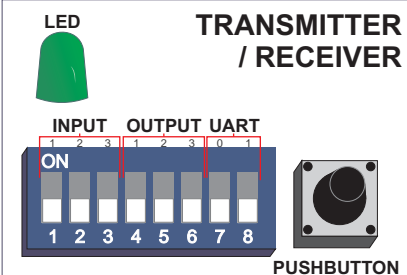

STEP 2

Press the pushbutton for 8 seconds. The LED will flash 6 times to indicate that erase was successful.

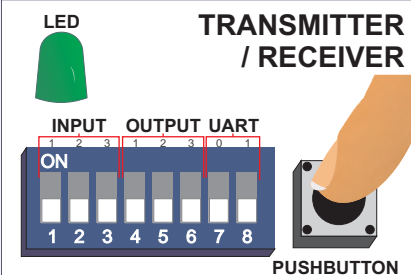

Repeat this procedure with the other RF-Unit.

TO USE THE RF-UNIT AS A REPEATER

No programming necessary. Only install at the relevant position.

WIRING DIAGRAM FOR RF MODULE 240V SUPPLY

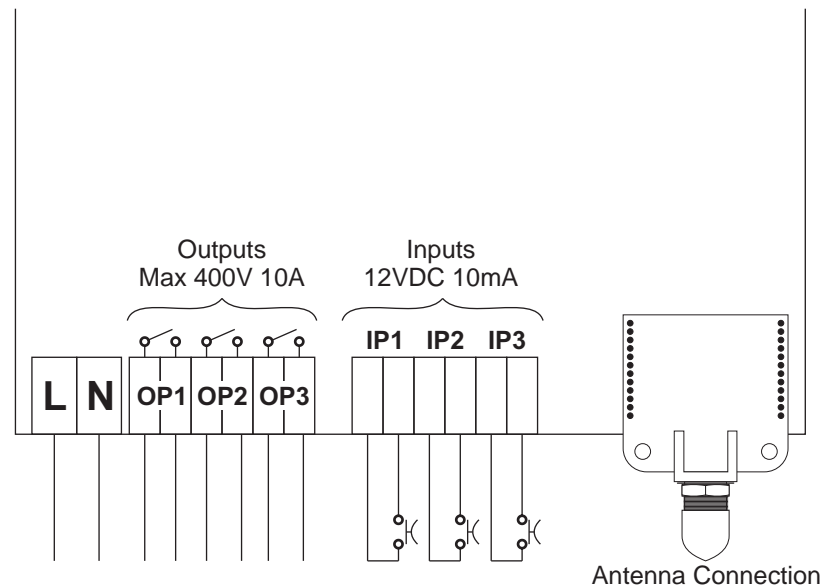

WIRING DIAGRAM FOR RF MODULE 11-15VDC SUPPLY

